

## Rockwell Hardness Testing System **Versitron**<sup>®</sup>

- Unaffected by Dirt
- Meets ASTM E18
- Fast and Easy
- Test can be performed in as little as 4 seconds
- Interchangeable Test Heads
  - For Calibration
  - Upgrades
  - Regular and Superficial Testing
- Capacities up to 36" vertical
- Made in the U.S.A.



### The Industry Workhorse

#### - Accurate for the Lab, Tough for the Shop

The Versitron<sup>®</sup> has the capacity to amaze first time users who are acquainted with the limitations of other Rockwell scale testers. Most experienced testing personnel are quite familiar with tedious requirements like using jack rests on large parts, constantly cleaning testers and test parts, slow test cycles and cutting parts so they can be tested.

The Versitron<sup>®</sup> changes all of that. Frequently cleaning of test parts is eliminated. Tests are performed in as little as four seconds even on manually activated machines. Large specimens can be clamped in seconds prior to applying the load without supports or tools and without affecting test results. Small tapers can easily be accommodated with standard components.

Large and small companies all over the world now find they can get fast, accurate, and repeatable test results even in bad operating conditions using relatively unskilled operators without significant service requirements.

## Clamping capability

The ability to clamp test parts provides significant benefits for many companies. Clamping eliminates the time wasted and improves test accuracy compared to using jack screws or cutting specimens. Also, diamond breakage can be eliminated, when caused by test parts shifting under load.

To clamp a part, operators simply lift it onto the anvil and clamp it into position by raising the elevating screw. Clamping is accomplished independent of any applied test loads. The capacity is about 240 foot/pounds so operators can clamp nearly anything they can lift. Even tapered parts can be clamped using ball anvils.

Clamping has no effect on the test results. The clamping shield attaches to the test frame which acts like a large C-clamp. It does not touch the indenter or shroud, although it surrounds them, and has no effect on the test loads.

The clamping shield pops in and out without tools so operators can perform small sample testing easily without the clamp. Even on parts that do not require clamping, the shortened clamping shield can be used to protect the indenter from incidental impact.

### Heavy-Duty Clamping

*Heavy specimens exerting up to 240 foot pounds can be clamped in seconds. At right is a 40 pound crankshaft. Test results are unaffected since the frame, not the test head, bears the clamping load.*



### Protected Diamonds

*The removable clamping shield protects the diamond indenter from being struck by the test specimen during handling, because the indenter is recessed by  $1/32$ ". Also, when test samples are clamped the indenter is protected from damage resulting from test samples shifting under load.*



### Test-Surface Referencing for Accuracy

At left is a photo showing the unique indenter system of the Versitron®. Immediately surrounding the indenter is an indenter shroud. The purpose of the shroud is to sense the position of the indenter relative to the test surface when the preload has been applied. Should the test specimen deflect under major load, the shroud travels with the test surface to compensate by maintaining that precise reference position with the test surface, so the test result will remain accurate.

Common test conditions such as vibration or dirty environments, test samples with oily residues, and thin test pieces can cause test error due to deflection during the load - often with a significant effect on test results. The error resulting from deflection can be eliminated or substantially reduced with the Versitron®.

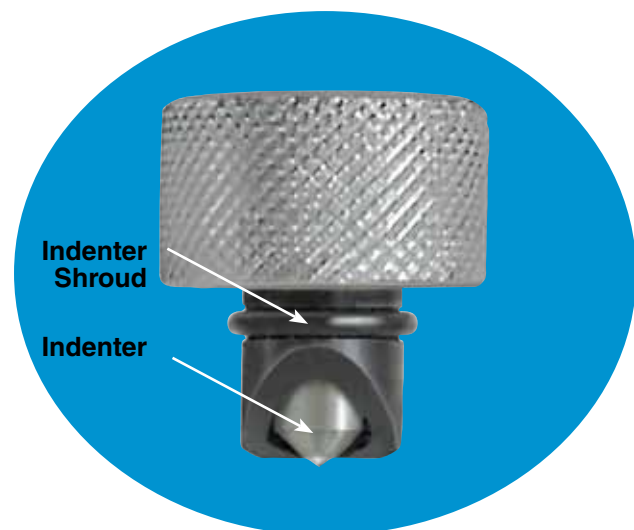



**Unaffected by Dirt**

*The Versitron® test results are not sensitive to dirt. A hair under a test block will completely ruin most testers' results but the Versitron® remains accurate.*



**Low Maintenance**

*This older model is still operating in conditions that would disable other testers. In good environments it requires less cleaning and service.*

**Top-Loading Configuration**

Top-loading testers apply both the preload and full load through the test head. The preload load is not applied through the elevating screw.

The entire load system is a modular and self-contained unit with many advantages over traditional systems.

A single pull of a lever by the operator will perform the entire test cycle, applying both the preload and full load and providing a test result in as few as two seconds without operator influence. Versitron® systems with a motor drive are started with a pushbutton or pedal.



**Modular Heads**

*The test heads can be installed easily so testers can be interchanged between regular and superficial ranges, or upgraded by adding new test heads as requirements change.*



**Quick & Easy**

*The Versitron® has the fastest test cycle of any tester - as fast as four seconds even on a manual tester. Operators require little training since it is so easy to operate.*

**Electronic functions**

- All testers have RS-232 output for data transfer
- Built-in Hardness Conversion Tables

At the press of a button, automatically convert a test result to another hardness scale, per ASTM E 140.\*

- Electronic Security Codes

Prevents unauthorized tampering of presets such as tolerances.\*

- High / Low Tolerances

User-assignable settings for part sorting and SPC calculations.

- Load Control

Load Lock feature prevents tests from being taken at the wrong test load for the hardness scale displayed.\*

- On-Board SPC Software Program

Store 1000s of test results and provide statistical displays and reports.\*

- DataView™ Data Collection through RS232 Output

Collect your data into data files on a computer and get advanced statistical capabilities. DataView software is specially built for hardness tester data collection with unusual features like scale conversion and round correction.

\*Applies to Advanced Digital test heads, Models AT130RDS & AT130-SRDS only

## Features & Functions

### 1 - Test Head

Available in Basic Digital and Advanced Digital versions. Interchangeable with any Versitron® frame.

### 2 - Display

Large, bright, easy-to-read.

### 3 - Head Carriage Height Adjustment

(T-frame models) Adjusts test head height for sitting or standing operating position. Option MT4 - Head Carriage Motor Drive - can motorize this movement.

### 4 - Drives

Optional automatic test cycle with electric motor drive or high speed air drive; Single motion load application with standard manual lever.

### 5 - Test Frame

Bench models with large vertical capacities from 8.2" to 36". Also available in custom versions as well.

### 6 - Elevating Screw Base Plate

Removes in seconds for testing large specimens. (T-frames only)

### 7 - Heavy Duty Elevating Screw

### 8 - Clamping Shield

Holds difficult to test parts securely to the anvil. Also helps to protect the indenter area. The indenter shroud references the position of preload upon contact with the test surface to reduce incorrect test results.

### 9 - Load Selection Wheel

Dial in load selection and load locking.

### 10 - Keypad

Durable design for abusive environments with easy-to-understand functions.



16" T Frame with Advanced Digital Test Head and Electric Motor Drive



## The Versitron® System and ASTM E-18

Newage bench-style Rockwell scale hardness testers meet ASTM E-18 for Rockwell hardness testing. In fact, Newage has taken a very active role in the ASTM committee for developing E-18. Additionally, Newage took the lead in bringing discrepancies to light between American and International test results, and has been selling test blocks and diamonds for over a decade and a half that met either national or international standards.

Newage worked since the beginning with NIST to resolve this discrepancy, resulting in the development of NIST traceability for Rockwell scale hardness testing, which has brought American Rockwell testing into line with the rest of the world.

## Anvils & Accessories



### AT/5309 Diamond Spot Anvil –

Provides controlled deformation for testing soft or thin metals where the anvil effect is assumed.

### \*AT/5310 2" Diameter Flat Anvil –

For testing of parallel face specimens.

\*AT/5311 Spot Anvil – For testing against small areas or confined spaces.

\*AT/5312 Shallow Vee Anvil – For testing small cylindrical specimens.

\*AT/5313 Wide Vee Anvil – For testing cylindrical specimens.

AT/5318 Set of 3 Small Anvils – For small parts testing. Includes flat, spot, and round anvils and anvil adapter.

AT/5319 Flattened Ball Anvil – Test parts with tapered or non-parallel faces can be tested quickly and accurately with this anvil. The flat face is rotated to take up the taper on the underside of the test piece, while the test surface is clamped perpendicular to the indenter. Also available: AT/5319V Flattened Ball Anvil with vee for testing tapered rounds.

### AT/5322 Anvil Adapter to fit 3/4" post diameter anvils –

Standard or special anvils built for conventional hardness testers can be adapted to the Versitron® by reducing the spindle hole diameter.

### AT/5510 Flexible Arm Electric Light –

With on-off switch, holding fixture, 115V transformer, and a power cord.

Test Blocks – A complete range available.



AT/5535 Audible Alarm – A loud signal for out-of-tolerance conditions. For DS model test heads only. (Must be ordered at time of test head purchase.)

9011 8" Anvil Table – Circular 8" dia. work surface to support large test pieces



9012 Jominy Test Fixture – A special fixture which enables end quench testing at specified intervals along the axis of a Jominy test piece. The test specimen is automatically held in proper alignment. The hand wheel controls test positioning. The base is graduated at 1/16" or 1 mm intervals, specify with order.

Automatic Jominy Systems are also available with single and multiple piece fixtures and fully-automatic motorized positioning and reporting.

\*AT/5620 Vinyl Protective Cover – Specify test frame model.

AT/5324 Adjustable Cylinder Vee Anvil – with two positions. (not pictured)

AT/5420 Custom Gooseneck Adapter – Designed to allow testing of inside surfaces or outside surfaces obstructed by the test part configuration. (Not shown).

AT130B Floor Cabinet – To mount any bench model. A hole is drilled for the elevating screw. Includes an area for test blocks, anvils, etc. Measures 24½" W x 28" D x 34" H.



Flattened Ball Anvil for testing tapers

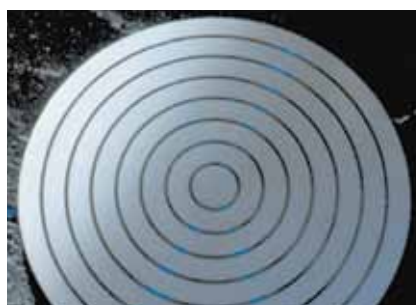

8" Diameter Anvil Table



Floor Cabinet #AT130B





\*Standard accessories included with every system.

## Versitron® Components & Specifications

The modular design of the Versitron® allows you to put together the system that best suits your hardness testing needs. We've arranged our testing system model numbers to help guide you through the selection process. The sections on these pages can be used to help you decide what combination of frame, test head, drive, and options to choose.

The modular Versitron® components can be combined into the perfect system for your requirements. All three test head styles, the two most common test frames, and both the manual and motor drive options can be seen below. (See the captions under each picture for actual part numbers.)

## Versitron® Components to make a complete system:

- Frames: 
- Heads: 
- Drives: 
- Indenters & Accessories:  See following pages



AT130-RDS system with AT130-N frame and manual lever



AT130-RDS test head with AT130-T frame and manual lever



AT130-RDS test head with AT130-N frame and AT130-MT2-N motor drive

### Test frames Frames not shown to same scale

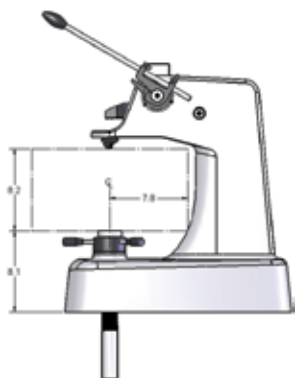

#### AT130-N

##### “N” Conventional Bench Frame

With clamping capability, heavy duty elevating screw.  
8.2” vertical capacity  
7.8” horizontal capacity  
Base Dimensions: 15”x 21”  
Shipping Weight: 140 lbs.



#### AT130-T (-28), (-36)

##### “T” Column Bench Frame

With clamping capability, adjustable head carriage height positioning (also see optional AT130-MT4), heavy duty elevating screw.  
16”, 28”, or 36” vertical capacity,  
8.8” horizontal capacity  
Base Dimensions: 15½”x 25.5”  
Shipping Weight: 266 lbs. - T.

*Test Frame Accessories: T and N frames include: 2” flat anvil, spot anvil, two vee anvils, vinyl dust cover, set of Allen wrenches, accessory kit*

Test Heads		
<p><b>Regular Rockwell</b> 150, 100, 60 kgs</p> <p><b>Superficial Rockwell</b> 45, 30, 15 kgs</p> <p><b>Combination Rockwell*</b> regular &amp; superficial</p> <p><b>Electronic &amp; Output Features</b></p>	<p><b>Advanced Digital</b></p> 	<p><b>Basic Digital</b></p> 
	AT130-RDS	AT130-RDB
	AT130-SRDS	AT130-SRDB
	AT130-2DS	AT130-2DB
	<p><b>Advanced Digital System includes:</b></p> <ul style="list-style-type: none"> <li>• Adjustable high/low tolerance indicator</li> <li>• Time-at-load settings from 0-99 seconds</li> <li>• Display of average and standard deviation</li> <li>• Printout of test results, histogram, and total statistics (when connected to a printer)</li> <li>• 16 character alpha numeric display</li> <li>• Nine function keys and numeric keypad</li> <li>• Automatic hardness scale conversion</li> <li>• Minimum thickness calculation</li> <li>• Programmable lot number for printouts</li> <li>• Automatic averaging every "N" tests</li> <li>• 2400 memory capacity</li> <li>• Load lock</li> <li>• RS-232 Output</li> <li>• Optional and Custom programming</li> </ul>	<p><b>Basic Digital System includes:</b></p> <ul style="list-style-type: none"> <li>• Adjustable high/low tolerance indicator</li> <li>• Time-at-load settings from 0-99 seconds</li> <li>• Display of average and standard deviation</li> <li>• Printout of test results, histogram, and total statistics (when connected to a printer)</li> <li>• 2400 memory capacity</li> <li>• RS-232 Output</li> </ul>
<p><b>Test Head Accessories</b></p>	<p>All test heads come complete with a certified diamond indenter, 1/16" Tungsten carbide certified ball indenter and two certified test blocks.</p>	
<p>* Includes both regular and superficial units with one digital display unit.</p>		
Drive Options		
<b>Electric Drive, N Frame:</b>	AT130-MT2-N	AT130-MT2-N
<b>Electric Drive, T Frame:</b>	AT130-MT2-T	AT130-MT2-T
<b>Pneumatic Drive, N or T:</b>	AT130-MT3	AT130-MT3
<b>Manual Lever Operation</b>	(Default Operation)	(Default Operation)
Other Options		

**AT130-X3 - Extended Software Package:** (Advanced Digital heads only) **Expanded memory** (up to 6400 readings) **Automatic round correction** for cylindrical testing **Time and date printout** next to each result **Xbar-R charting** **Split Memory** provides up to 28 separate memory files for tracking and data management of individual parts or processes, even with multiples of the same scale, i.e: five HRC scales. **Test Block Verification** tracks the tester's accuracy and repeatability against stored test blocks. Test block data is stored by serial number, ASTM spec limits, and hardness value for up to three ranges per hardness scale. Operator is prompted for test blocks to run and given pass or fail messages according to test results. Printouts include certificate of verification and Xbar-R charting.

**AT130-MT4 - Head Carriage Motor Drive:** motorizes the raising and lowering of test head position (available with all T frames).

**AT130-X5 - Effective Case Depth Calculation Program:** Creates a case curve and calculates the effective case depth.

**DV-X1B - DataView® Hardness Testing Software:** Operates on most Windows based computers to store and display data, provide round correction and more. Request DataView Product Bulletin.

## Indenters, Shrouds, & Clamping Shields

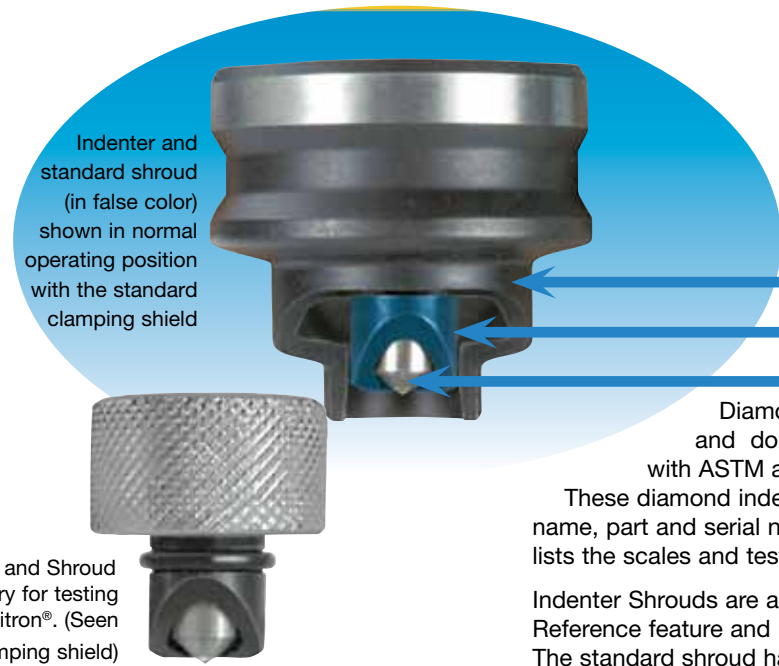

Indenter and standard shroud (in false color) shown in normal operating position with the standard clamping shield

Indenter and Shroud are necessary for testing with the Versitron®. (Seen without clamping shield)

Diamond Indenters are carefully checked and double-checked to verify compliance with ASTM and international specifications. These diamond indenters are marked with Newage name, part and serial numbers. The supplied certificate lists the scales and test results from calibration.

Indenter Shrouds are an integral part of the Test-Surface Reference feature and must always be used in all testing. The standard shroud has a cutaway for better vision of the test surface. (See page 2 for description)

Clamping Shields are used in many applications but are not required for testing and are not part of the test cycle. They attach to the test frame - not the test head. All clamping shields can be easily snapped in or out without tools.

### Indenters

**Diamond Indenters** are used on higher hardness metals in the standard and/or superficial hardness ranges, depending on their calibration certificates. C scale is the most common diamond scale

**Ball Indenters** are used on softer metals in the standard and/or superficial hardness ranges, depending on their calibration certificates. Larger balls are used on softer materials. Special Brinell indenters are provided for use with the Brinell Conversion Packages seen below.



#### Certified Diamond Indenters

Part#	Description
AT/5110-07	C scale
AT/5103-07	C and A scales
AT/5109-07	All superficial N scale
AT/5107-07	Tapered C, A, or D scales, use with shroud AT/5404
AT/5106-07	Tapered N scale, use with shroud AT/5404



#### BALL INDENTERS

Part#	Description
AT/5111W-07	1/16" Tungsten carbide ball; B, F, G, and all T scales
AT/5112W-07	1/8" Tungsten carbide ball; E, H, K, and all W scales
AT/5113W-07	1/4" Tungsten carbide ball; L, M, P, and all X scales
AT/5114W	2.5mm Tungsten carbide ball; HB/30 Brinell scale*
AT/5115W	5mm Tungsten carbide ball; HB/5 Brinell scale*

\* Requires optional Brinell package - See below. Not to ASTM.

### Brinell Conversion Packages

The following conversion packages enable Brinell scale measurements on any advanced regular scales digital test head. Includes: carbide ball indenter, Brinell scale test block (except for cast iron), and software upgrade.

Part#	Description
5010D	Digital pkg. for carbon steel; uses 187.5kg load (corresponding to 3000kg/10mm) and 2.5mm ball indenter to test scales HB30 100-40
5011D	Digital pkg. for cast iron; uses 187.5kg load (corresponding to 3000kg/10mm) and 2.5mm ball indenter to test scales HB30 110-400
5012D	Digital pkg. for light alloys; uses 125kg load (corresponding to 500kg/10mm) and 5mm ball indenter to test scales HB5 40-200

**Standard Clamping Shields** are cut away on one side to provide visibility of the indenter contact point while providing some protection of the diamond from possible damage.

**Enclosed Clamping Shields** provide total indenter protection. They are used in circumstances where standard shields are inadequate.

**SHORTENED ENCLOSED CLAMPING SHIELDS** provide total indenter protection in automatic applications.

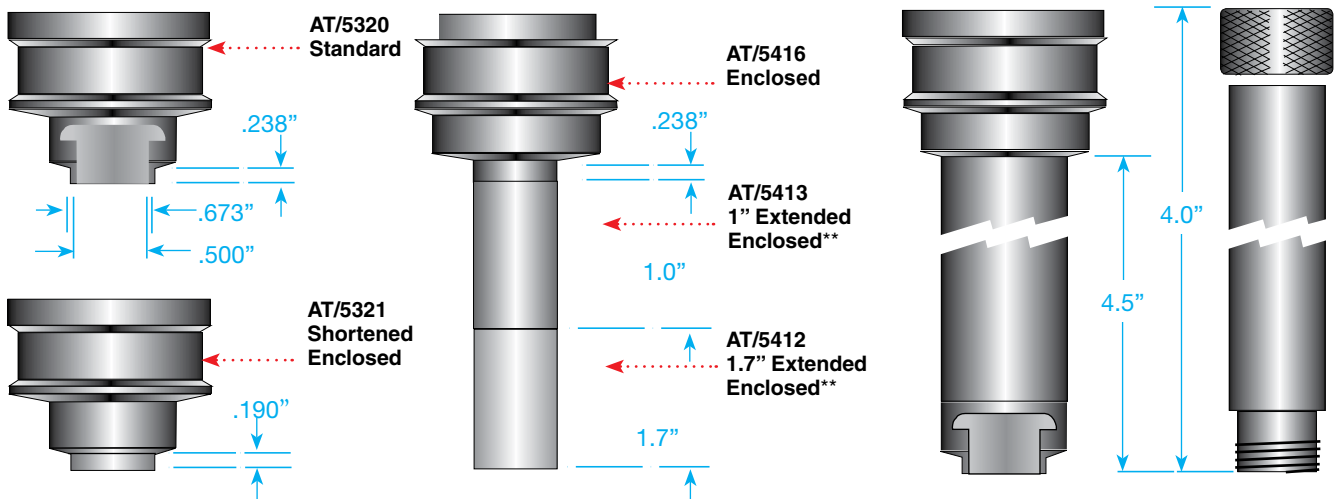

\*\* Part of a package that also includes an indenter extension and an extended enclosed shroud.

**AT/5411 4" Extension Package** – includes extended clamping shield with extensions for shroud and indenter. Used with any standard length shroud.

Indenter Shrouds

**Standard shrouds** are used in most applications. They are cut away on one side to provide visibility of the indenter contact point, and apply a 3/8" contact area on the workpiece.

**Enclosed Indenter Shrouds** are used in automatic testing applications or manual applications where standard shrouds prove inadequate.

**Double Taper Shrouds** are used in applications requiring a narrow contact area with the workpiece (.085" minimum) or requiring full visibility of the indenter contact point. Double Taper Shrouds are not normally used with a clamping shield.

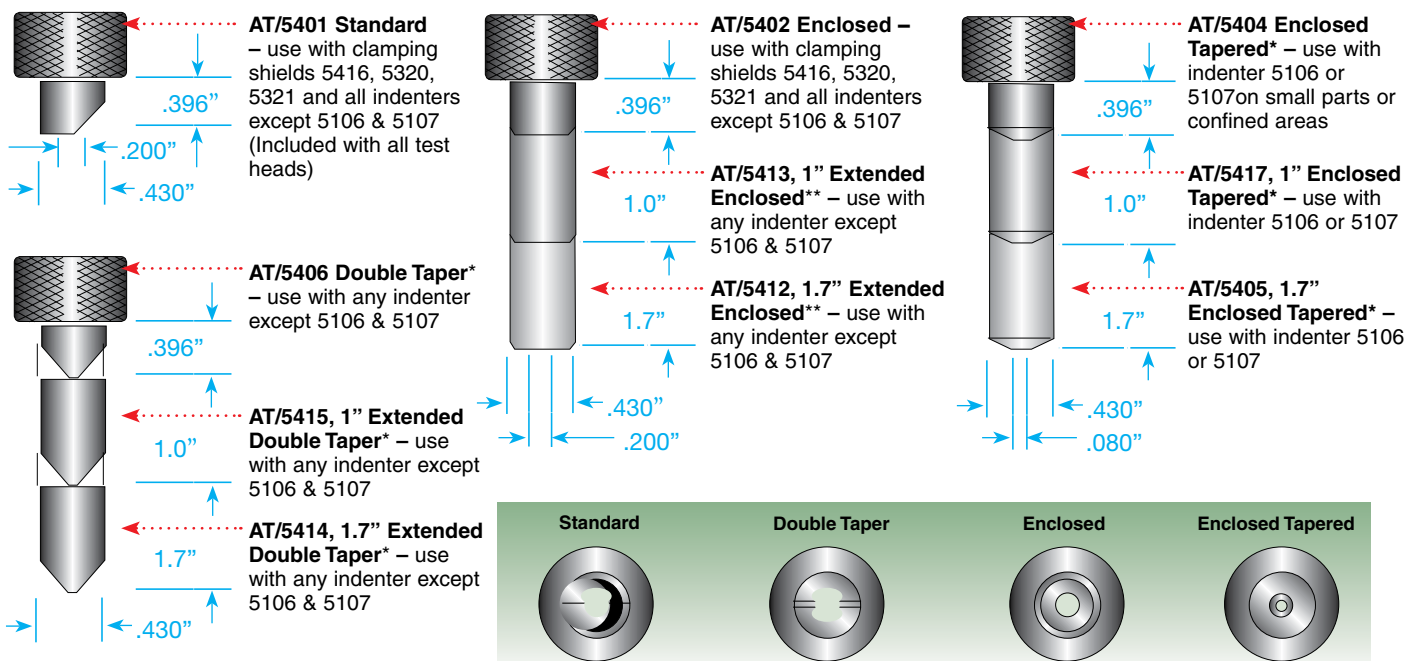

\* Not normally used with a clamping shield. \*\* Part of a package that also includes an indenter extension and an extended enclosed clamping shield.

## Automation and Customization

Newage Testing Instruments has been providing its customers with the benefit of its vast experience in the area of design and construction of Rockwell and Brinell type testing systems for over 50 years. We have produced standard and custom systems for major manufacturers and government agencies covering virtually every type of industry base imaginable. Many of these systems, in continuous use and operation, are a true testament of the reliability and longevity that are design features of every Newage Custom and Automatic Test System. The photos provided below further illustrate some of our capabilities and achievements in these areas.



*Custom Automatic Brinell for automotive engine blocks.*



*Custom Automatic Brinell with depth & optical measurement and automatic surface preparation.*



*Custom Versitron® with vibratory bowl feeder and tested part sorting.*



*Custom Versitron® Test System for automotive crankshafts.*

**Worldwide Sales & Service Support**

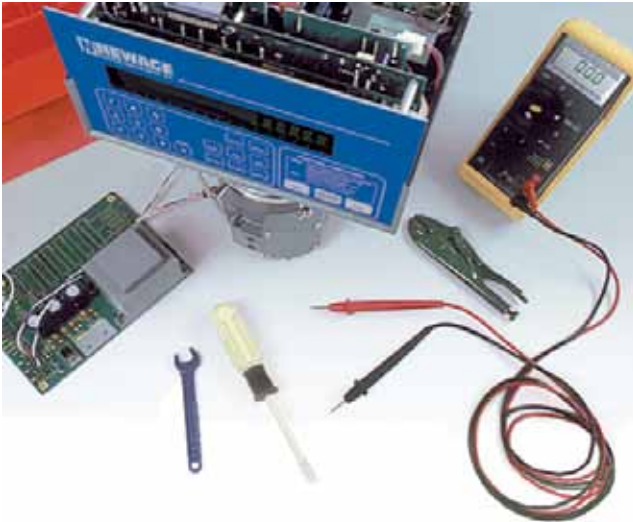

Newage Testing Instrument's sales and service staff and our associates have the capability to support hardness testing needs anywhere in the world. Additionally, Newage Versitron® test heads can be shipped to our Pennsylvania location for factory service.

We provide a loaner/rental program for some models (subject to availability) to keep our customers in operation while their test heads are serviced.

For details call 800-806-3924 (or 215-355-6900 in Pennsylvania and outside the US).

**Here is what you can expect from the Newage Service Network:**

- For emergency service, you'll receive a fast, on-site response by a qualified technician.
- Standardized procedures with detailed documentation that will pass your internal and external audits.
- Verification, calibration, preventive maintenance, and repairs on many different types of hardness testing systems, regardless of make and model. Newage stocks commonly used spare parts for testers from other manufacturers.
- All vehicles and service personnel are fully insured for liability for on-site service at your facility.
- Call 800-317-1976 to schedule on-site service of your hardness tester.
- Call 800-806-3924 to get answers to questions in any area of hardness testing, or receive engineering assistance on any hardness testing application. (Call 215-355-6900 in Pennsylvania or outside the US)

**Newage Testing Instruments offers calibration service which is accredited to A2LA.**



## Other Testers from Newage



Indentron®  
Rockwell Scale Tester  
for the lowest GR&R.



ME-2 Rockwell  
Scale Tester - an  
Economical Choice



B.O.S.S.® Brinell Optical Scanning  
System Reduces Operator Influence on  
Scope Measurements.



Automatic Brinell  
for High Volume  
Without Scopes



NB3010 Bench  
Brinell - Semi  
Automatic



C-Clamp  
Portable - Tests  
to ASTM E10



Portable Pin Brinell  
Tests Where Other  
Brinells Won't.



PB7000 Series  
Production Brinell  
Testing



HiLight™ Brinell  
Scope with  
Unique Features



MT90 Automatic Traverse Micro  
Tester Provides the Fastest Case  
Depth Testing on the Market



C.A.M.S.™ Advanced Computer-  
Driven Package or Upgrade Your  
Current Tester



HMV2  
Microhardness  
Tester with  
Advanced Control



### AMETEK Test & Calibration Instruments

A business unit of AMETEK Measurement & Calibration Technologies offering the following industry leading brands for test and calibration instrumentation.

### Chatillon Force Measurement

Chatillon has been a hallmark in the industry since 1835. The hand held gauges and motorized testers have earned their reputation for quality, reliability and accuracy and they represent the de facto standard for force measurement.

### Lloyd Instruments

#### Materials Testing Solutions

Materials testing machines and software from Lloyd Instruments guarantee the highest level of performance and capability for production testing, quality control, laboratory testing, research and education to provide expert materials testing solutions.

### Davenport Polymer Test Equipment

Allows critical polymer parameters to be determined, including melt flow index and melt flow rate, intrinsic viscosity (IV) measurement of moisture-sensitive PET polymers and polymer density measurement.

### Texture Analysers

The comprehensive program provides the platform to perform rapid, general food testing and detailed texture analysis on a diverse range of foods.

### Newage Testing Instruments

Newage offers a comprehensive range of hardness testers, durometers, optical systems and software for measurement, data acquisition and analysis.

### JOFRA Calibration Instruments

The inventor of the portable high precision dry-block temperature calibrators. The calibration instruments program also covers precision thermometers and temperature baths, temperature sensors hand held instruments for pressure calibration and process signal calibrators for easy control loop calibration, measurements and simulation.

### M&G Pressure Testers & Pumps

Pneumatic floating-ball or hydraulic piston dead weight testers with accuracies to 0.015% of reading.

**AMETEK®**  
TEST & CALIBRATION INSTRUMENTS

Newage Testing Instruments, Inc.  
820 Pennsylvania Blvd • Feasterville • PA 19053 • USA  
Tel: 215-355-6900 • Fax: 215-354-1803  
newage.info@ametek.com

[www.hardnesstesters.com](http://www.hardnesstesters.com)

AMETEK Denmark (Scandinavia)  
Tel +45 4816 8000 • ametek@ametek.dk

Lloyd Instruments Ltd. (UK)  
Tel +44 (0) 1243 833 370 • uk-far.general@ametek.com.uk

AMETEK SAS (France)  
Tel +33 (0) 1 30 68 89 40 • info.lloyd-instruments@ametek.fr

AMETEK Europe GmbH (Germany)  
Tel +49 0 2159 9136 70 • apie@ametek.de

AMETEK Singapore Pvt. Ltd. (Singapore)  
Tel +65 484 2388 • aspl@ametek.com.sg

Information in this document is subject to change without notice. ©2011 by AMETEK, Inc., www.ametek.com. All rights reserved.